

PROJECT: _____

SCHEDULE: _____ DATE: _____

PREPARE BY: _____

NOTES: _____

DESCRIPTION

naturaLED® Slim Area Light Tennis is constructed with a durable, die-cast aluminum housing and excellent thermal design and is the perfect lighting solution for tennis courts and walkway. It provides uniform, consistent color with a wide range of wattage selections to replace up to 1500W HID fixtures. Our fixtures are DLC Premium certified and IP66 rated with four types of mounting options available: Pole Mount, Slip Fitter, and Yoke Mount. Compatible integrated autonomous and photocell motion sensors are available as options to address your needs. Energy savings can be as much as 85% while eliminating maintenance costs in labor, lamp, and ballast replacement.



Rated Life 50,000 Hours
Warranty 5 Years













APPLICATIONS

Tennis Courts, Walkways, Fields

FEATURES

- DLC Premium
- IP66 Rated
- IK08
- ETL Listed/ cETL Listed
- Color Temp: 4000K
- Voltage: 120-277V
- Power Factor: >0.9
- Built-in Surge Protection: 10KV
- Beam Angle: Type IV, Tennis Court Type
- Dimmable: 0-10V
- CRI: >80
- Operating temperature: - 40°F~122°F
- Low Voltage Output for Sensors
- Contractor Friendly Mounting Options
- Aluminum Die-cast housing
- Finish: Epoxy Powder Coat
- Color: Black (RAL#9005)
- 5 Year Warranty
- Optional for Purchase: Mountings, Sensors, Photocell, Pole Brackets, Lens, Receptacles

ACCESSORIES

	Pole Mount Arm		Shorting Cap
	Slip Fitter		Photocell
	Yoke Mount		Lens
	Receptacle		Pole Brackets
	Sensors		Arms - 5' Pole Top
	Surge Protection		Mount Adapters

SAMPLE NUMBER		FXSAL400/840/BK/TT			
FAMILY	SERIES	WATTAGE	CRI/COLOR TEMP	COLOR	LENS
FX Fixture	SAL Slim Area Light	400 400 Watt	840 CRI80 4000K	BK Black	TT, T4 Tennis Court Type Type 4



SPORTS COURT LIGHTING

AREA LUMINAIRES

ORDERING

*P= Premium DLC / *S = Standard DLC

Watts (W)	Ordering Code	Description	CCT (K)	Lumens (Lm)	Equiv. Wattage (W)	Color	Lens	IP66 Rated	DLC (S/P)
420	9593	FXSAL400/840/BK/TT	4000K	63,749	1000-1500W	Black	Tennis Type	•	P
420	9594	FXSAL400/840/BK/T4	4000K	63,879	1000-1500W	Black	Type 4	•	P

DIMENSIONS

400W
22.00-lbs

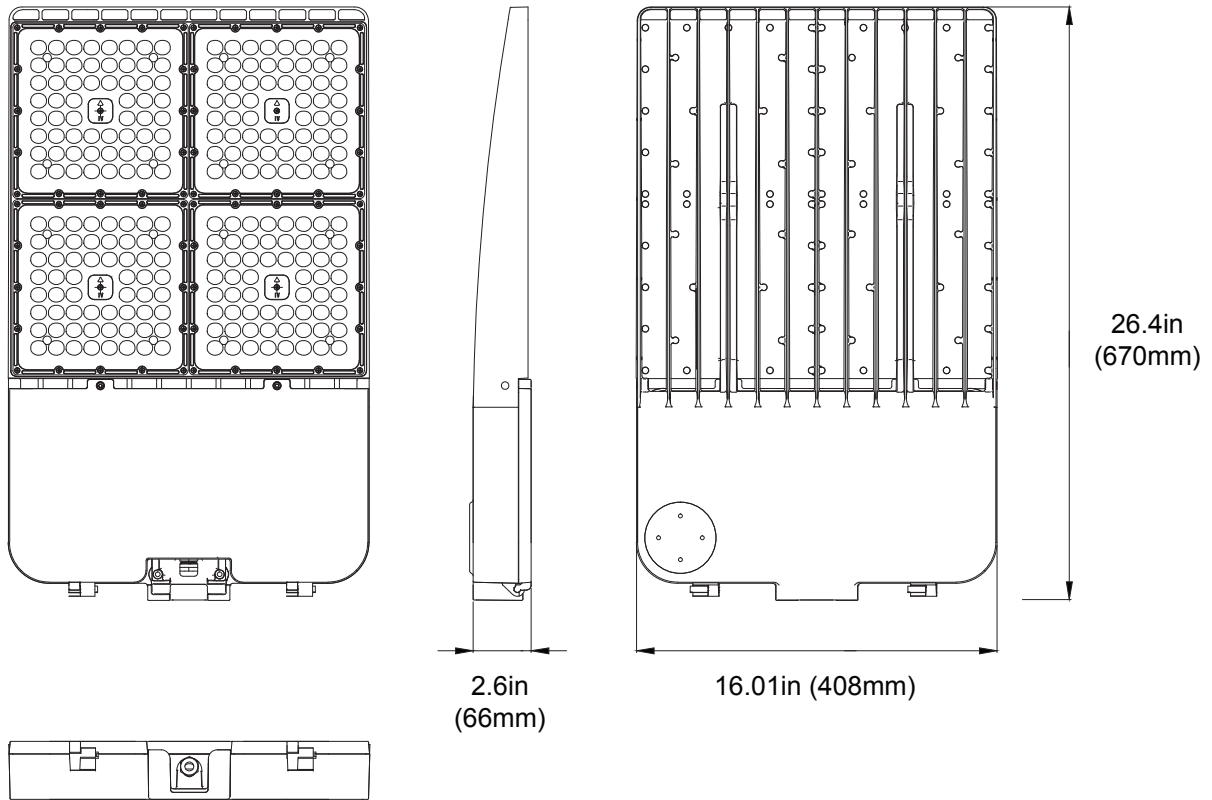

SPORTS COURT LIGHTING

AREA LUMINAIRES

Regular SAL SAL TYPES

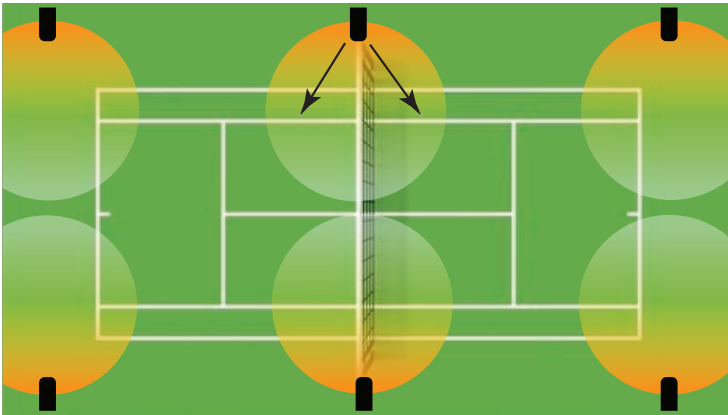

Sports Court SAL SAL TYPES

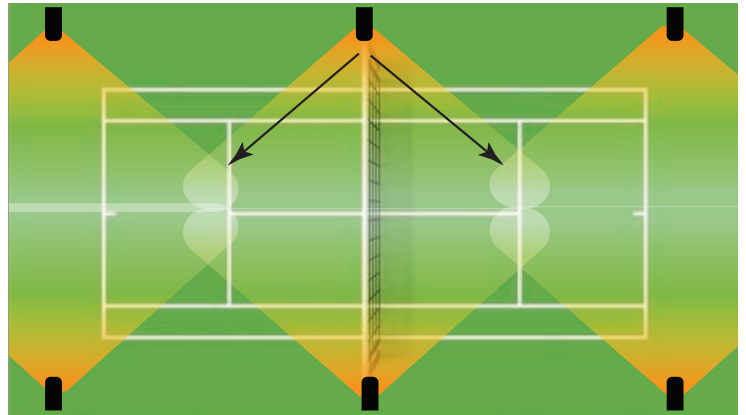

SAL Sports Court offers wider beam spread designed for tennis courts and fields application.

Regular SAL LUMENAIRE COVERAGE

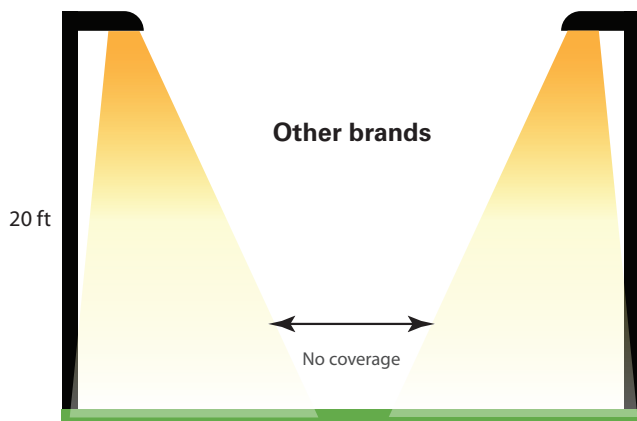

Sports Court SAL LUMENAIRE COVERAGE

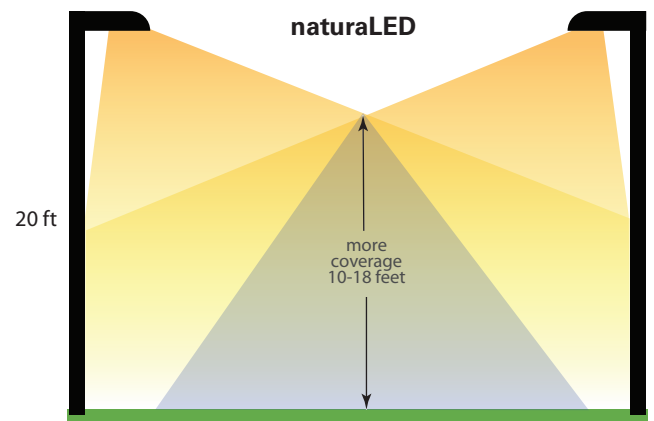

Regular SAL LENS TYPE

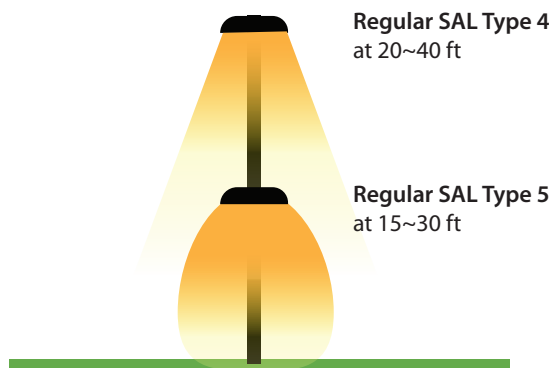

Sports Court SAL LENS TYPE

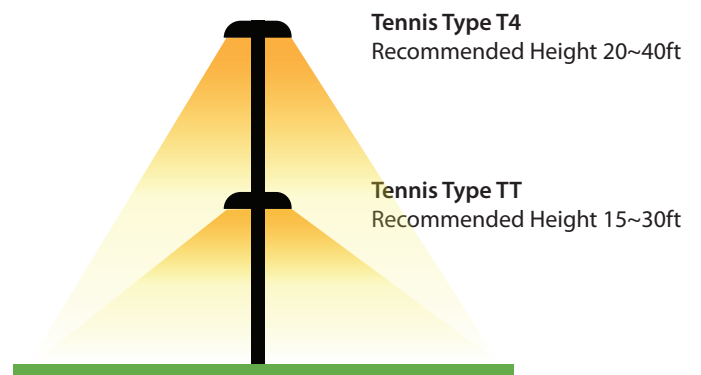

LIGHTING DISTRIBUTION

Tennis Type 4 recommended install height at 20~40 ft

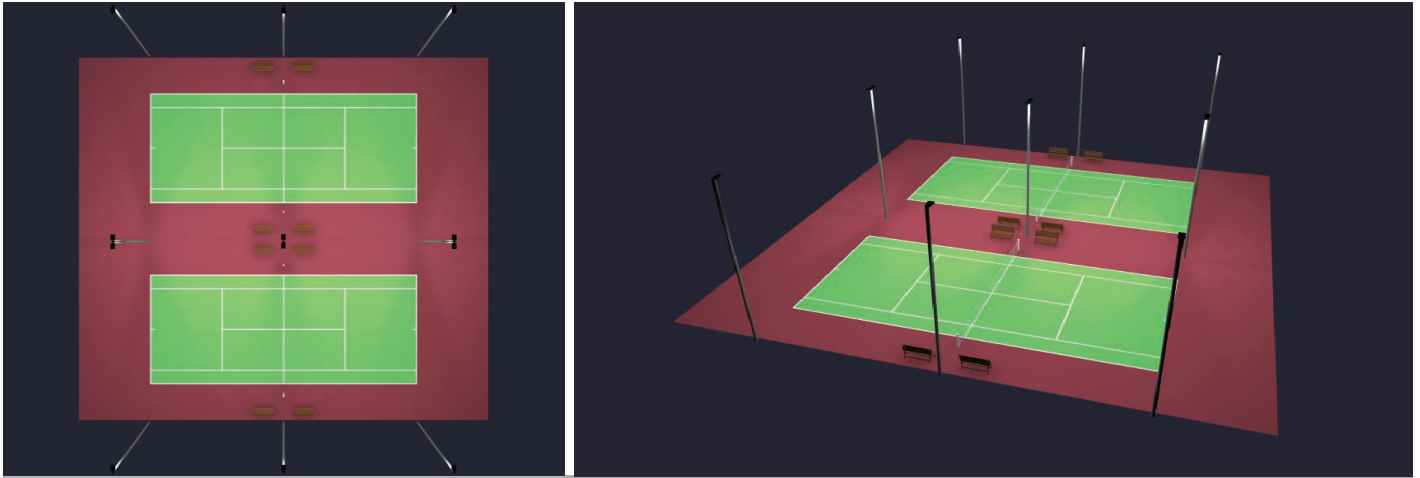

Image shown as : Tennis Type T4 / Height: 40 ft

Tennis Type TT recommended install height at 15~25 ft

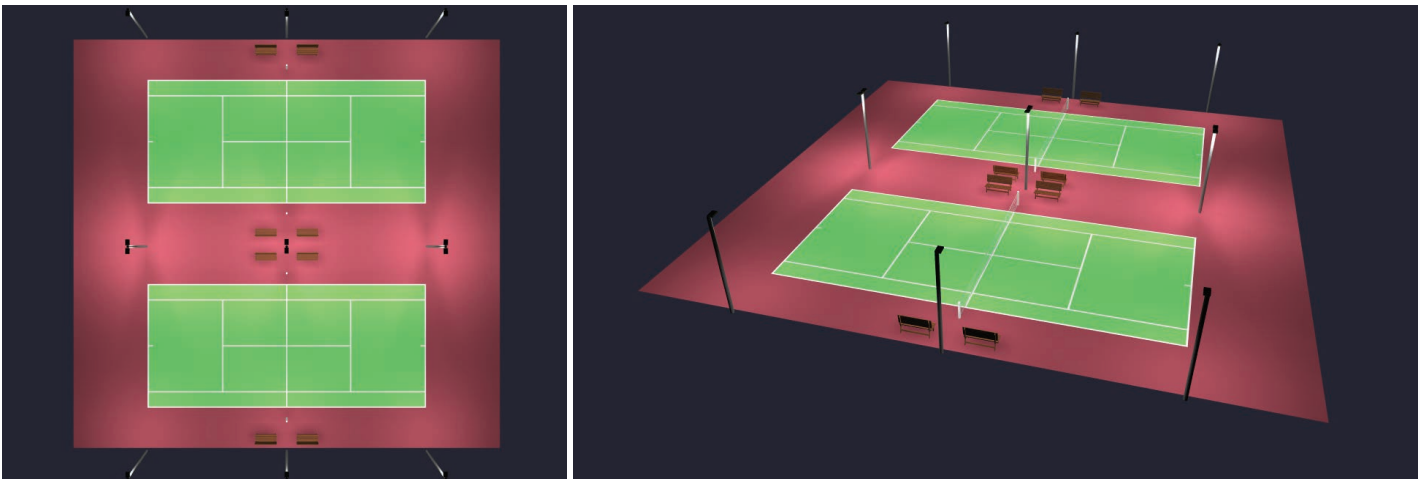
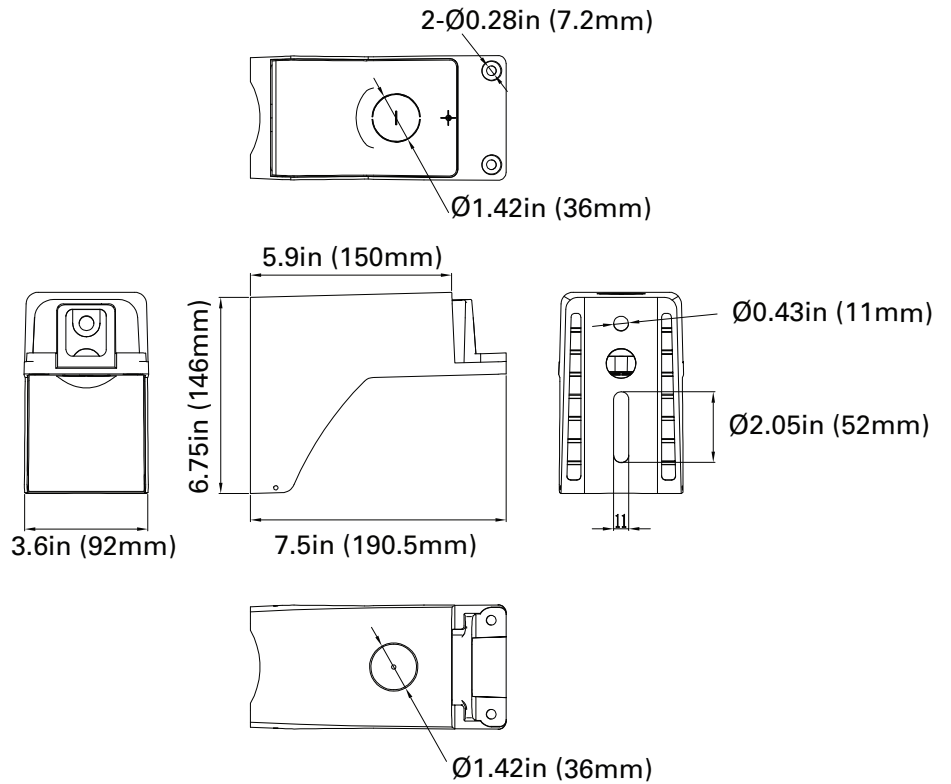
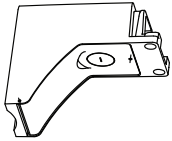

Image shown as : Tennis Type TT / Height: 20 ft

MOUNTINGS (Ordered Separately)

Pole Mount 6"

P10468 MT-AL/PM6/BK



Slip Fitter

P10470 MT-AL/SF/BK

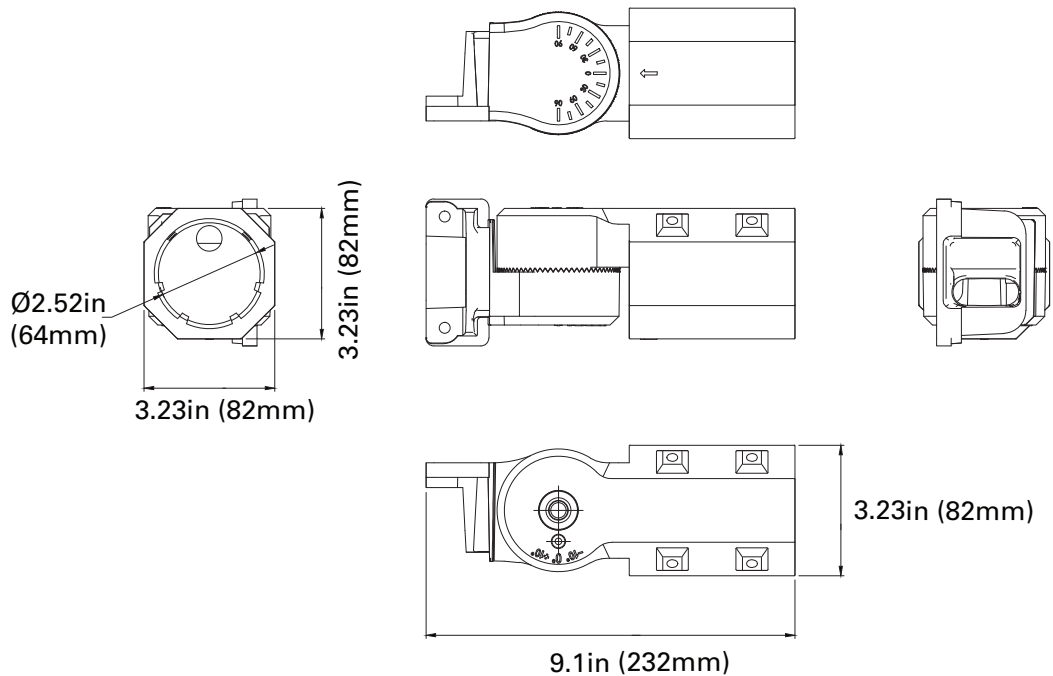
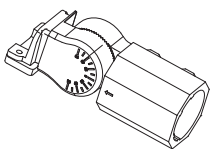

MOUNTINGS (Ordered Separately)

Yoke Mount 16"

P10472 MT-SAL/YK16/BK

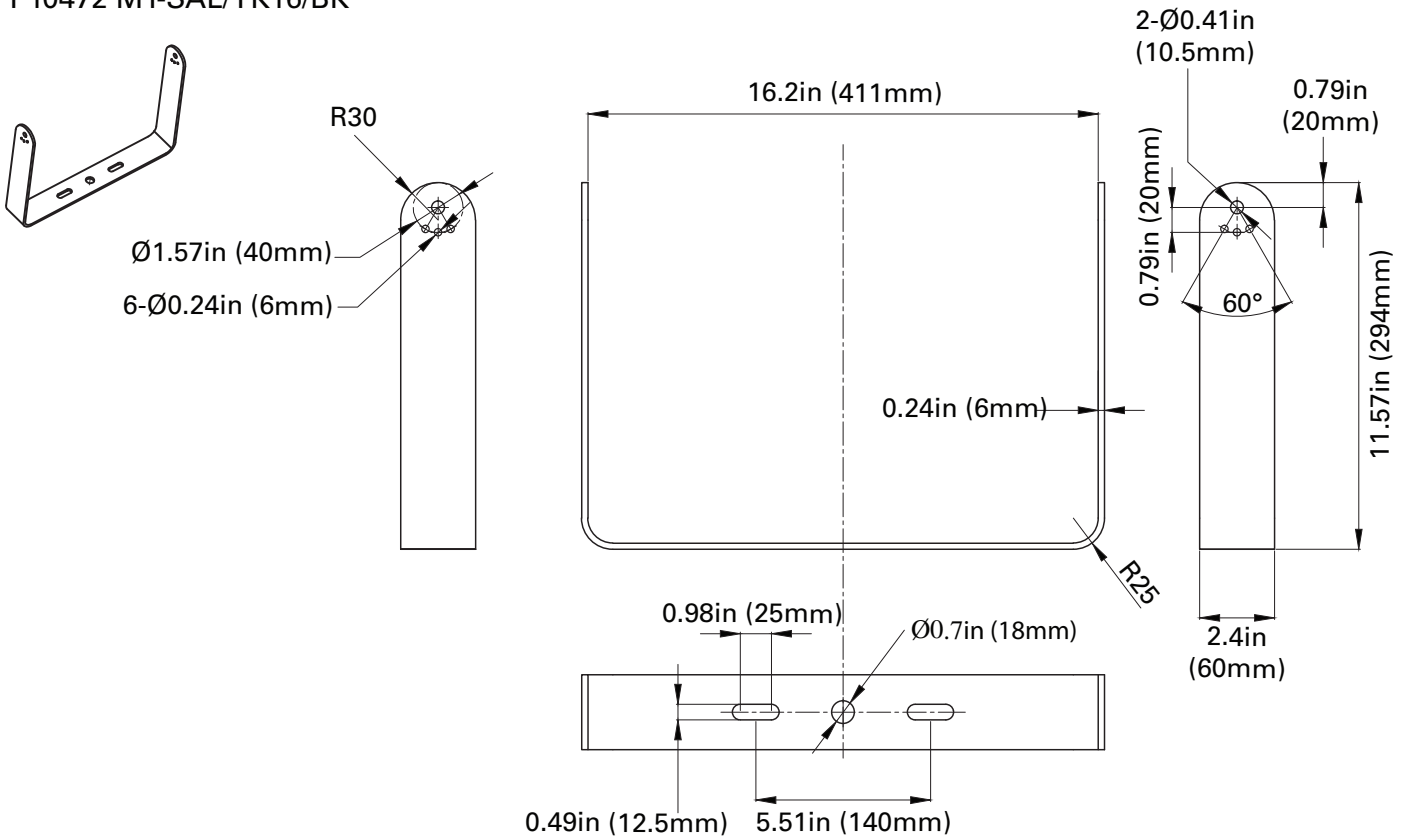





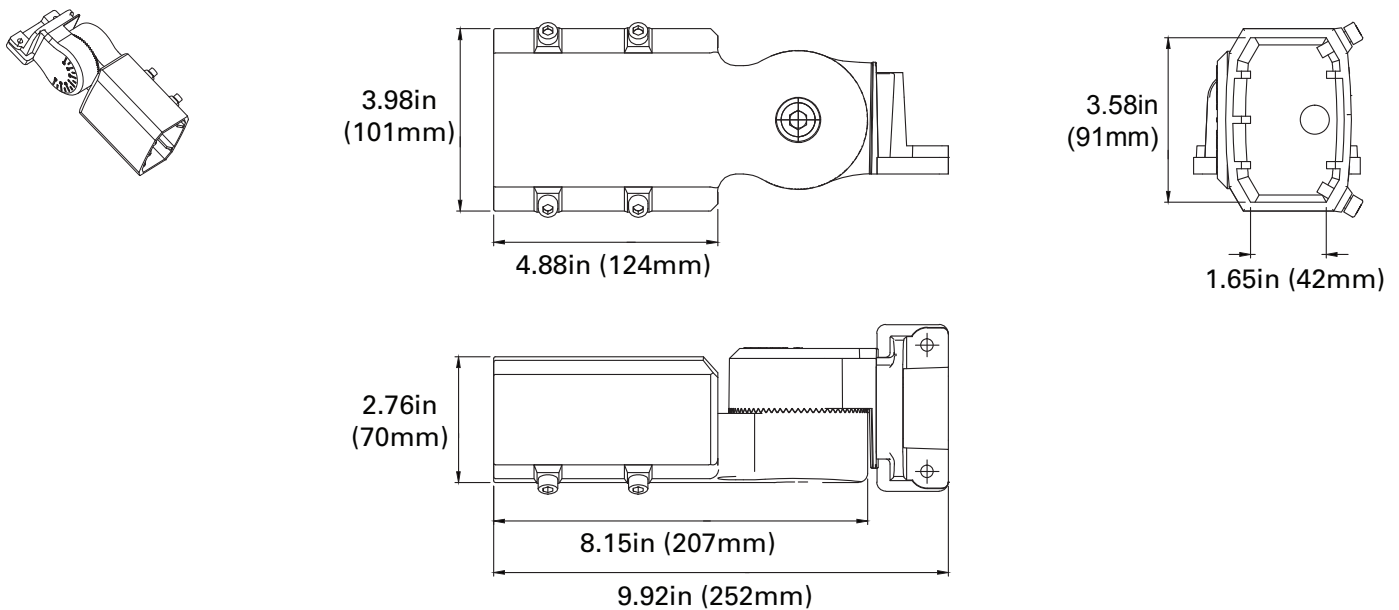





















Rectangle Slip Fitter

P10506 MT-AL/RSF/1.5x3.5/BK



ACCESSORIES (Ordered Separately)

	6" Pole Mount Arm P10468 MT-AL/PM6/BK (6" Pole Mount Arm-Black)
	Slip Fitter P10470 MT-AL/SF/BK (Slip Fitter Mount-Black)
	Yoke Mount P10472 MT-SAL/YK16/BK (16" Yoke Mount-Black)
	Rectangle Slip Fitter P10506 MT-AL/RSF/1.5x3.5/BK (Rectangle Slip Fitter 1.5"x3.5" for CAS and CAD-Black)
	Double Arm 3' - 70° P10559 MT-TAD70/5RT-3ft/BK (3' 70° Double Arms for Court Lighting. Fit to 5" Round Pole Top-Black)
	Double Arm 3' - 90° P10560 MT-TAD90/5RT-3ft/BK (3' 90° Double Arms for Court Lighting. Fit to 5" Round Pole Top-Black)
	Quad Arm 3' - 90° P10562 MT-TAQ90/5RT-3ft/BK (3' 90° Quad Arms for Court Lighting. Fit to 5" Round Pole Top-Black)
	Single Arm 5' P10526 MT-TAS/5RT-5ft/BK (5' Single Arm for Court Lighting. Fit to 5" Round Pole Top- Black)
	Double Arm 5' - 70° P10527 MT-TAD70/5RT-5ft/BK (5' 70° Double Arms for Court Lighting. Fit to 5" Round Pole Top-Black)
	Double Arm 5' - 90° P10528 MT-TAD90/5RT-5ft/BK (5' 90° Double Arms for Court Lighting. Fit to 5" Round Pole Top-Black)
	Double Arm 5' - 180° P10529 MT-TAD180/5RT-5ft/BK (5' 180° Double Arms for Court Lighting. Fit to 5" Round Pole Top-Black)
	Quad Arm 5' - 90° P10530 MT-TAQ90/5RT-5ft/BK (5' 90° Quad Arms for Court Lighting. Fit to 5" Round Pole Top-Black)
	Slip Fitter Adapter Single Davit Arm P10509 MT-4SFA/BK (Mount - Area Light Slip Fitter Adaptor for 4" Diameter Single Davit Arm)

	Mount - Single Davit Arm for 3.5" Pole Top P10510 MT-3.5RTDAV4/38in/BK (Mount - 4" Diameter Single Davit Arm (38") for 3.5" Pole Top)
	Mount - Twin Davit Arm for 4" Pole Top P10511 MT-4RTDAV3.5-2180/BK (Mount - Twin 4" Diameter Davit Arm Adaptor for 4" Pole Top)
	Mount - Quad Davit Arm for 4" Pole Top P10512 MT-4RTDAV3.5-490/BK (Mount - Quad 4"Diameter Davit Arm Adaptor for 4" Pole Top)
	Shorting Cap P10053 SEN-PHO-LK-MT-SRT (Twist Lock Photocell Shorting Cap 120-480V 3 Prong)
	Photocell K141030 REC3PLK/PHO (Twist Lock Photocell & Receptacle 120-277V 3 Prong)
	Type Tennis Lens P10450 LENS-SAL-L-TT (Type Tennis Lens for SAL400W (4 per fixture))
	Type 4 Lens P10451 LENS-SAL-L-T4 (Type 4 Lens for SAL400W (4 per fixture))
	Twist Lock Receptacle P10141 REC3PLK (Twist Lock Photocell & Receptacle Mount 120-480V 3 Prong)
	P10142 REC7PLK (Twist Lock Photocell & Receptacle Mount 120-480V 7 Prong)
	Motion Sensors P10371 SEN-BRI619 (PIR Motion/Photocell 0-10V Bi-Level Control IP66 12-24V IR Sensor)
	P10316 SEN-BRI-RC100 (Remote Programmer for P10371)
	Surge Protection P10389 SPD-L-10KV-277 (Surge Protection 10KV 120-277V)
	P10390 SPD-L-20KV-277 (Surge Protection 20KV 120-277V)
	P10391 SPD-L-20KV-480 (Surge Protection 20KV 347-480V)

POLE BRACKETS (Ordered Separately)



Round Pole Mount Tenon
P10348 MT-3RTV2.5-1/BZ
(3" Round Pole with 2-3/8" Tenon)

P10349 MT-4RTV2.5-1/BZ
(4" Round Pole with 2-3/8" Tenon)

P10350 MT-5RTV2.5-1/BZ
(5" Round Pole with 2-3/8" Tenon)



Spoke Mount Bracket - 90°
P10359 MT-2.5RTBH2.5-290/BZ
(Spoke Mount Bracket with Double 2-3/8" -90°)

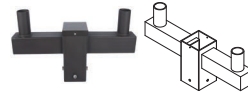

Square Pole Mount with Double - 180°
P10360 MT-4STV2.5-2180/BZ
(4" Square Pole Mount with Double 2-3/8" Tenon)



Square Pole Mount Tenon
P10351 MT-3STV2.5-1/BZ
(3" Square Pole with 2-3/8" Tenon)

P10352 MT-4RTV2.5-1/BZ
(4" Square Pole with 2-3/8" Tenon)

P10353 MT-5RTV2.5-1/BZ
(5" Square Pole with 2-3/8" Tenon)

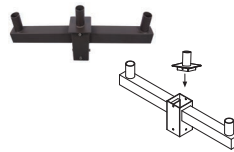

Square Pole Mount with Triple - 180°
P10361 MT-4STV2.5-3180/BZ
(4" Square Pole Mount with Triple 2-3/8" Tenon)

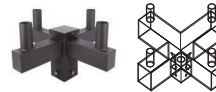

Square Pole Mount with Quad - 90°
P10362 MT-4STV2.5-490/BZ
(4" Square Pole Mount with Quad 2-3/8" Tenon)

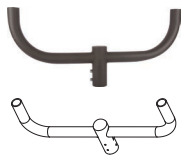

Bullhorns with Double -180°
P10356 MT-2.5RTBV2.5-2180/BZ
(Bullhorn with Double 2-3/8" Tenon-180°)



Wall Mount Bracket
P10363 MT-4WM2.5-1/BZ
(Wall Mount Bracket with 2-3/8" Tenon)

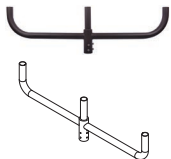

Bullhorns with Triple -180°
P10357 MT-2.5RTBV2.5-3180/BZ
(Bullhorn with Triple 2-3/8" Tenon-180°)

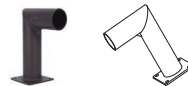

Angled Mount Bracket - 90°
P10364 MT-4WM2.5-190/BZ
(90° Angled Wall Mount with 2-3/8" Tenon)



Light Pole Cap
P10354 MT-4STC/BK
(4" Square Pole Cap)

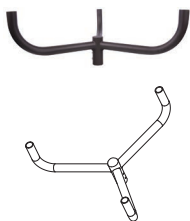

Bullhorns with Triple -120°
P10358 MT-2.5RTBV2.5-3120/BZ
(Bullhorn with triple 2-3/8" Tenon-120°)

MOUNTINGS (Ordered Separately)

Single Arm 5'

P10526 MT-TAS/5RT-5ft/BK

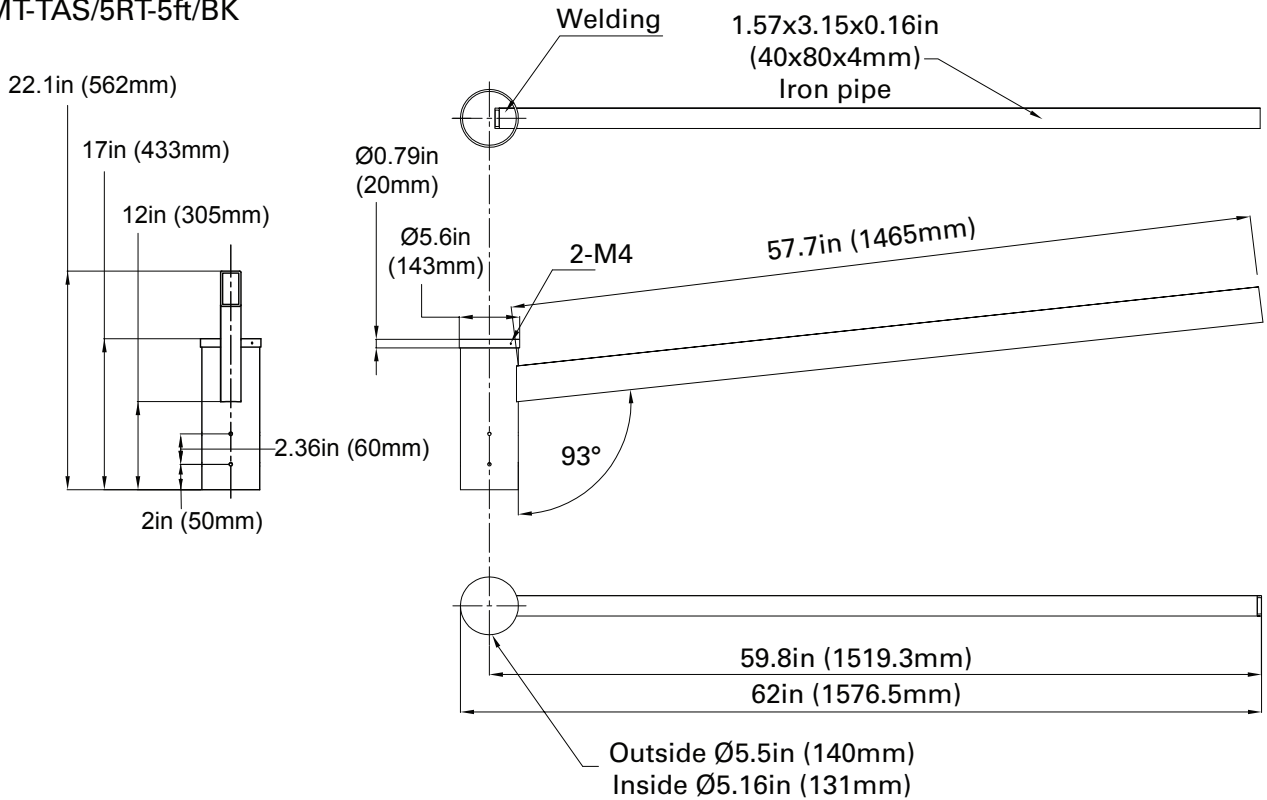

Double Arm 5' - 70°

P10527 MT-TAD70/5RT-5ft/BK

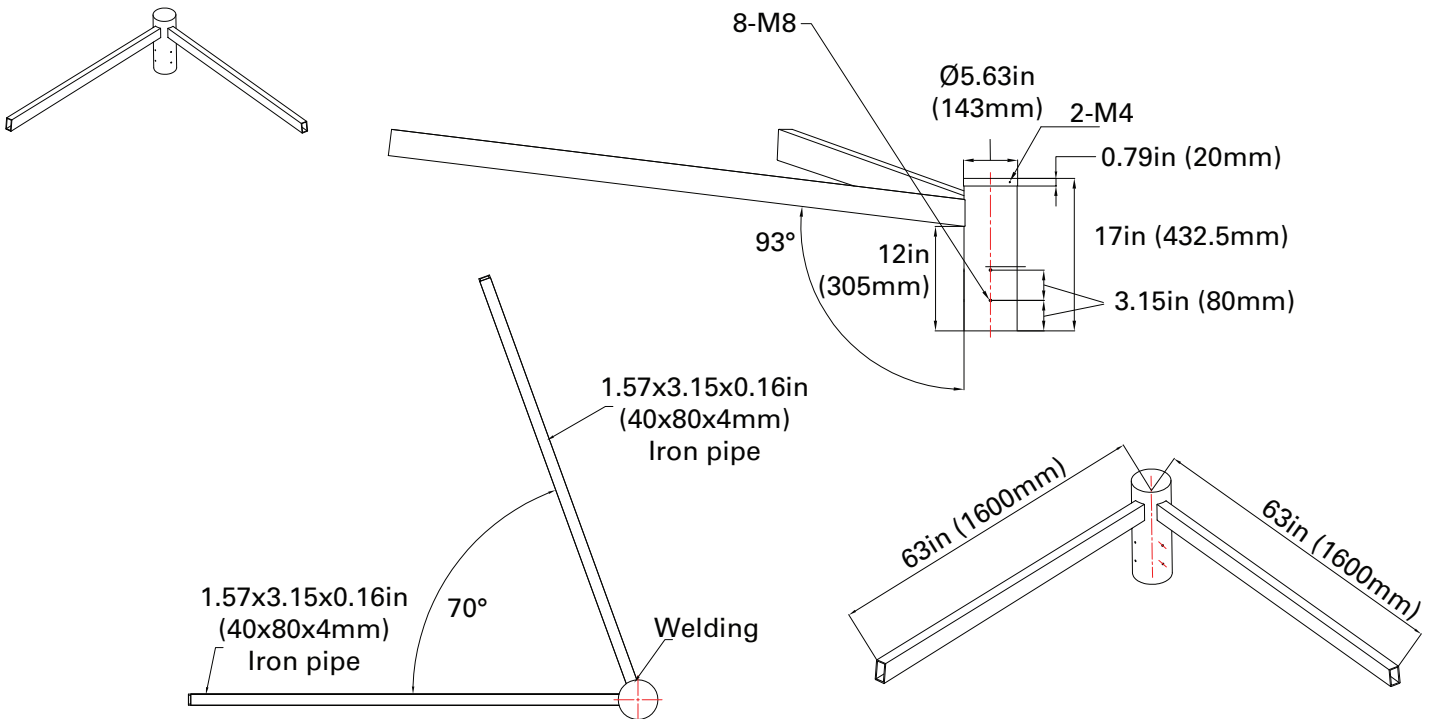

MOUNTINGS (Ordered Separately)

Double Arm 5' - 90°

P10528 MT-TAD90/5RT-5ft/BK

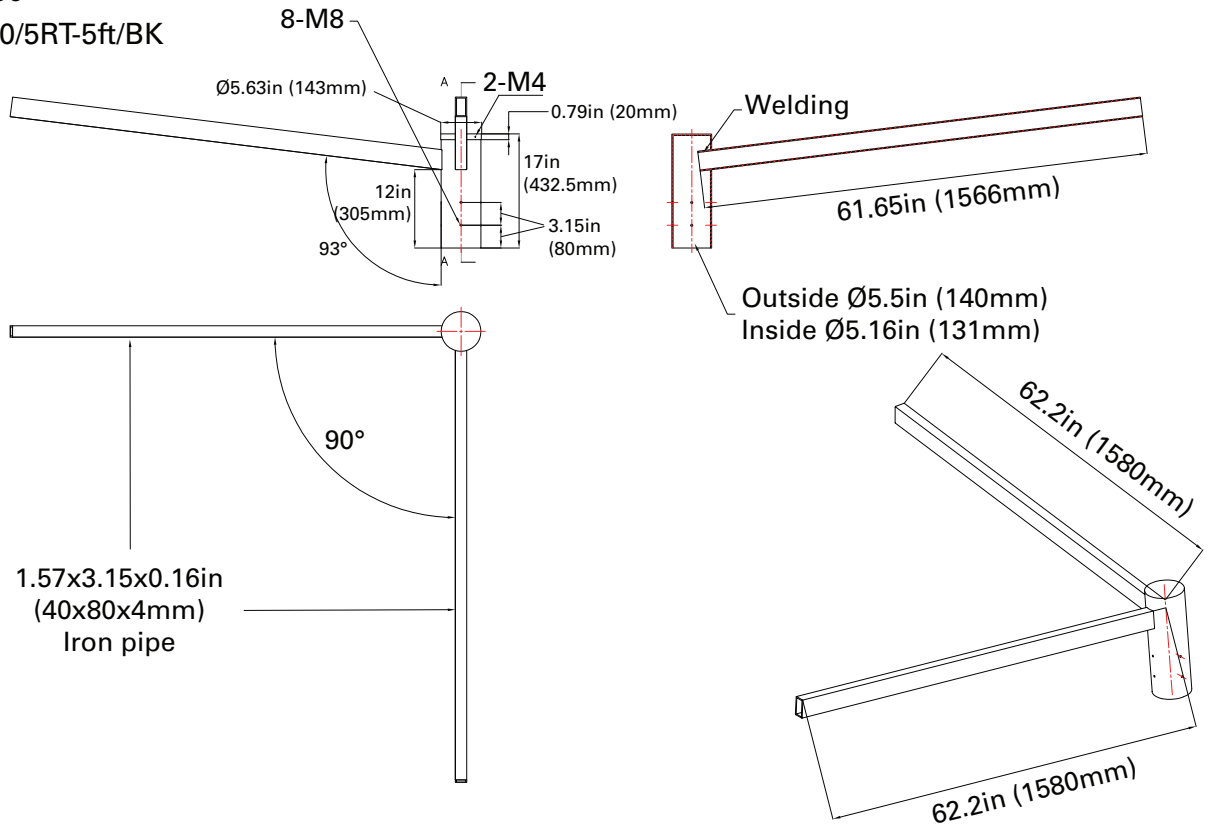

Double Arm 5' - 180°

P10529 MT-TAD180/5RT-5ft/BK

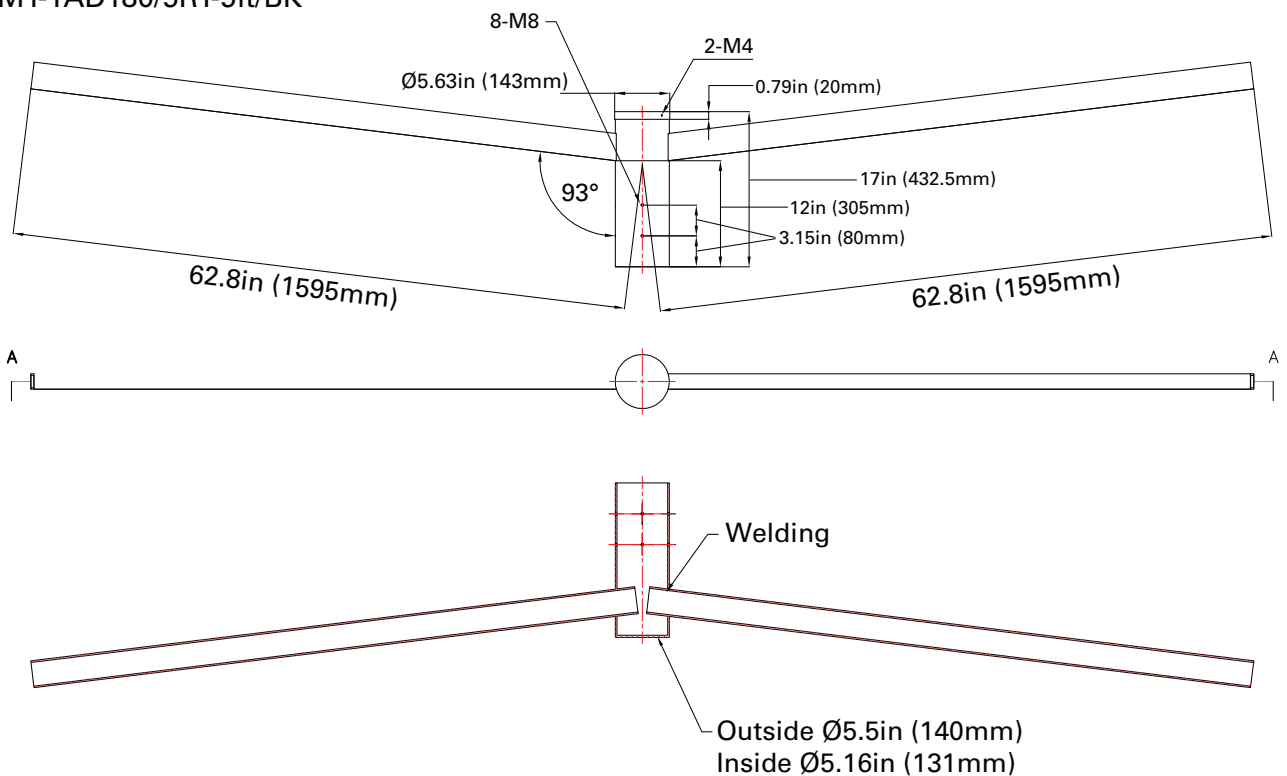

MOUNTINGS (Ordered Separately)

Quad Arm 5' - 90°

P10530 MT-TAQ90/5RT-5ft/BK

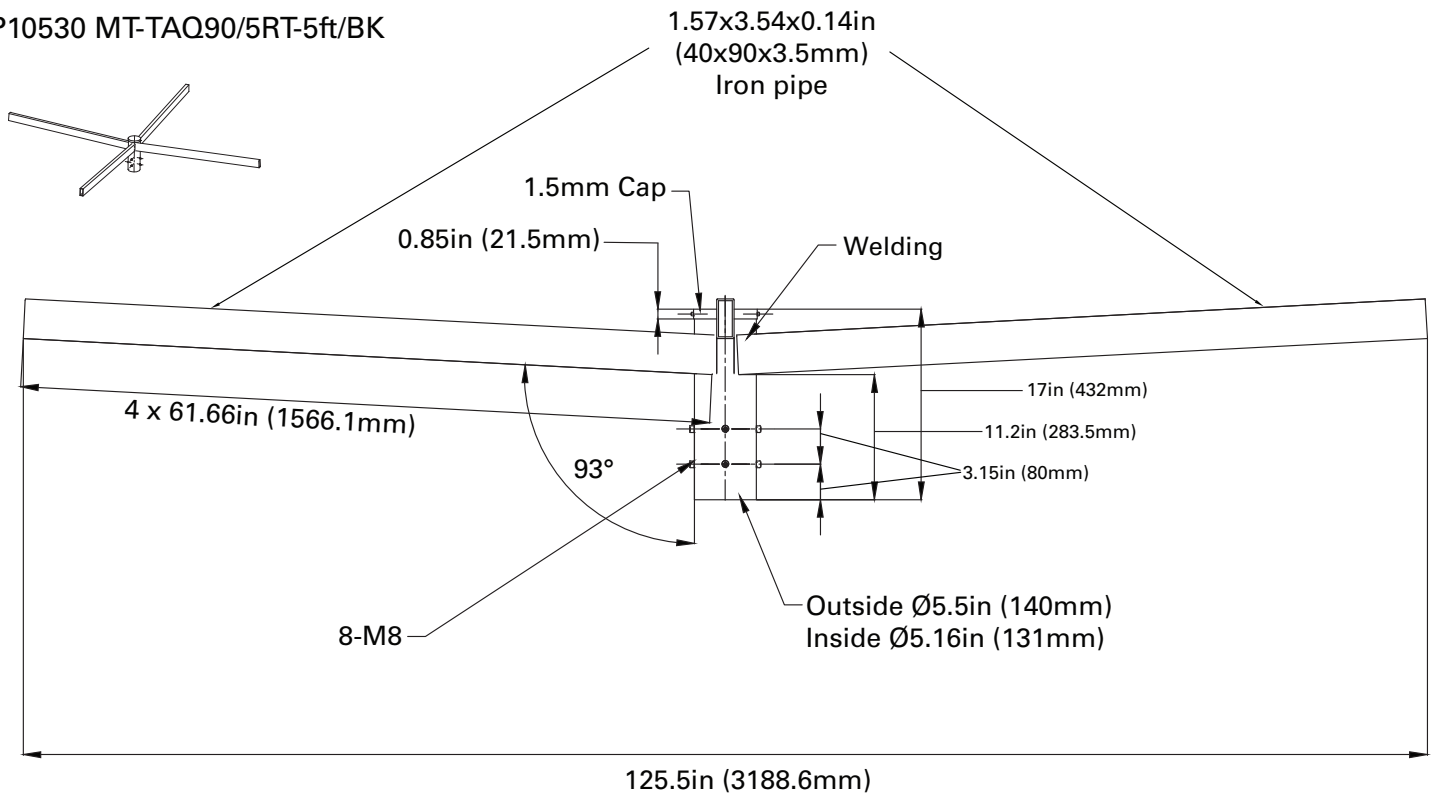

Slip Fitter Adapter Single Davit Arm

P10509 MT-4SFA/BK

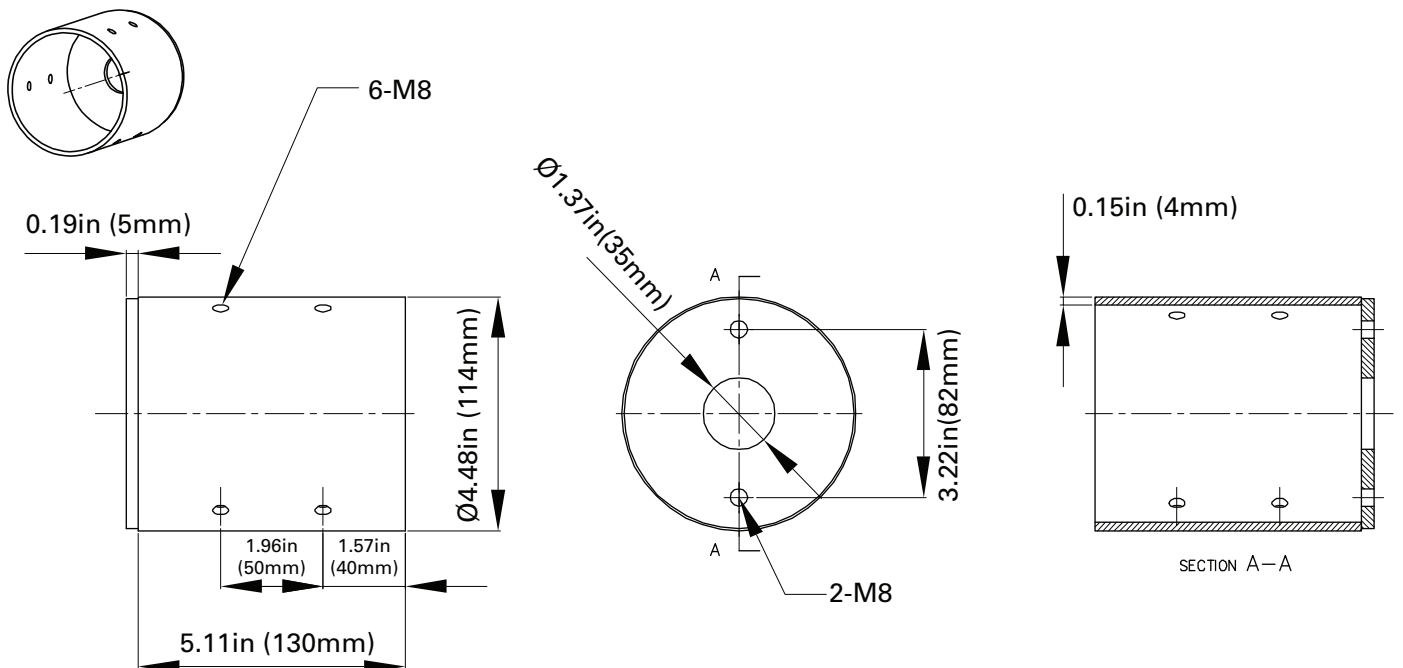

MOUNTINGS (Ordered Separately)

Single Davit Arm for 3.5" Pole top

P10510 MT-3.5RTDAV4/38in/BK

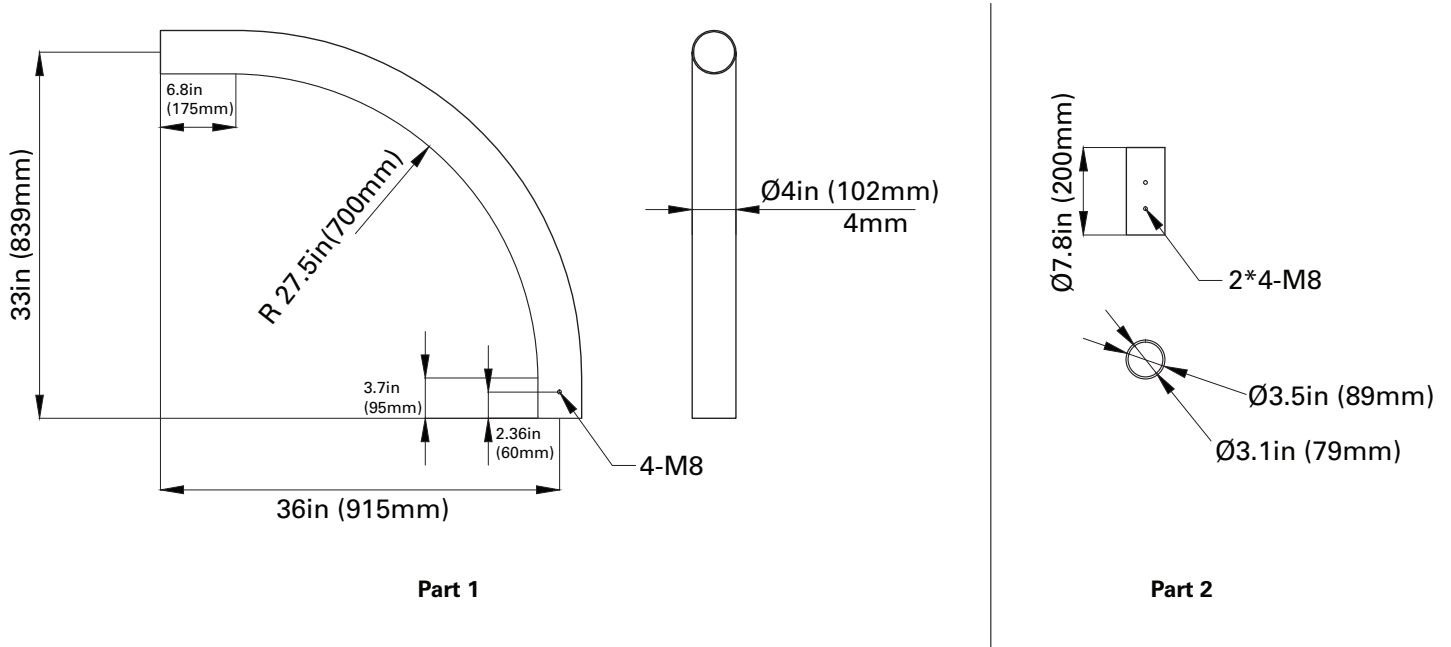

Twin Davit Arm for 4" Pole Top

P10511 MT-4RTDAV3.5-2180/BK

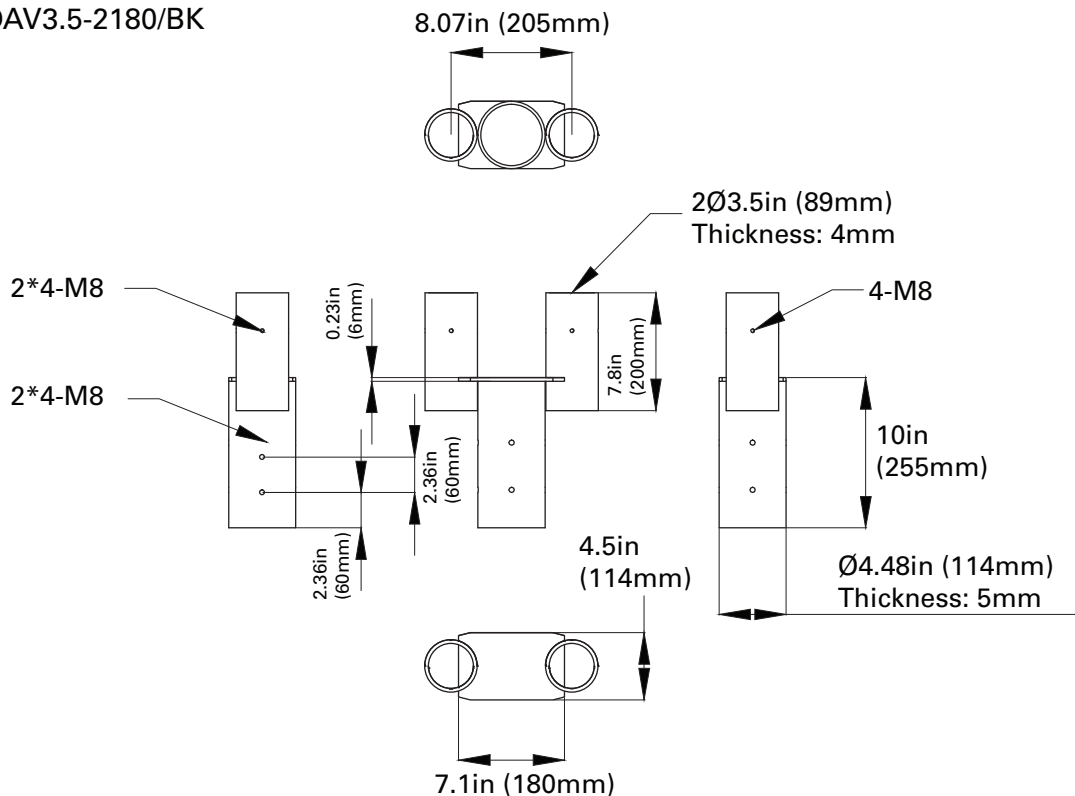

MOUNTINGS (Ordered Separately)

Quad Davit Arm for 4" Pole Top

P10512 MT-4RTDAV3.5-490/BK

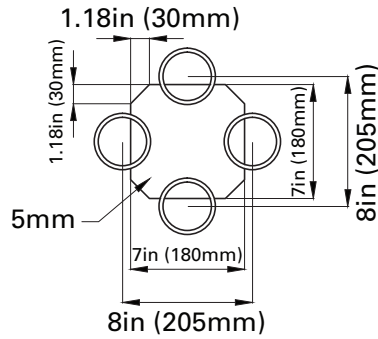
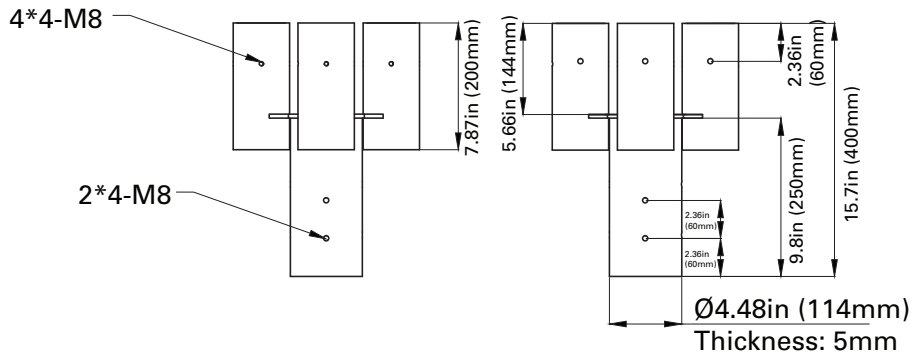
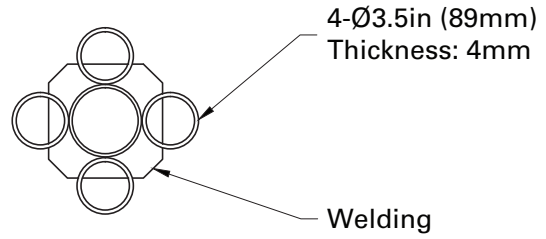
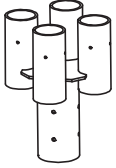

EPA RATING

400 Watt

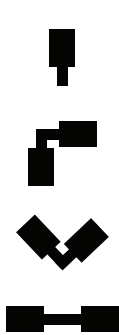

Config.	EPA (ft²)
1	0.326
2 @ 90°	1.01
2 @ 120°	1.05
2 @ 180°	0.70

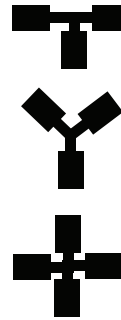

Config.	EPA (ft²)
3 @ 90°	1.04
3 @ 120°	1.34
4 @ 90°	2.00

PHOTOMETRICS CHART

400 Watt - Type TT
DLC Premium

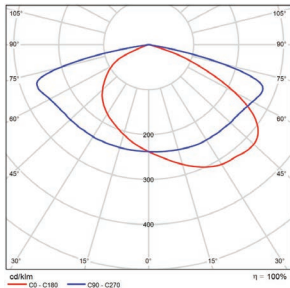

Center Beam fc	Beam Width
1,396 fc	8.4 ft 19.5 ft
339 fc	17.1 ft 39.6 ft
152 fc	25.5 ft 59.0 ft
86.0 fc	34.0 ft 78.5 ft
54.5 fc	42.7 ft 98.6 ft
38.0 fc	51.1 ft 118.1 ft

■ Vert. Spread: 103.9°
■ Horiz. Spread: 142.6°

400 Watt - Type 4
DLC Premium

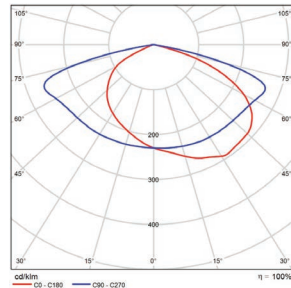

Center Beam fc	Beam Width
326 fc	19.8 ft 41.8 ft
82.8 fc	39.3 ft 83.0 ft
36.6 fc	59.1 ft 124.9 ft
20.6 fc	78.9 ft 166.7 ft
13.2 fc	98.4 ft 207.9 ft
9.16 fc	118.2 ft 249.7 ft

■ Vert. Spread: 111.8°
■ Horiz. Spread: 144.5°

PACKAGE

Case Qty 1 pc

